

Cedar Hot Tub Features:

- Made in Canada.
- Traditional, cooperage-style cedar hot tubs are hand-crafted from clear western red cedar.
- Using no electricity, this uniquely designed wood-burning hot tub heater takes 2 to 4 hours to heat up your tub of water (depending tub size) from 45°F to 105°F.
- Triangular seating construction allows bathers to see each other during the hot tub session.
- Easy to Follow assembly instructions with online video assistance.
- Filtration and chemicals are not required.
- Available in either a 3' or 4' deep tub and in 5', 6' or 7' diameter

Cedar Hot Tub Options:

- Solid Western Red Cedar 3 tier steps with railing.
- Insulated vinyl hot tub cover to keep the debris out of your cedar hot tub and the water warm over night. (available in 12 different colours)

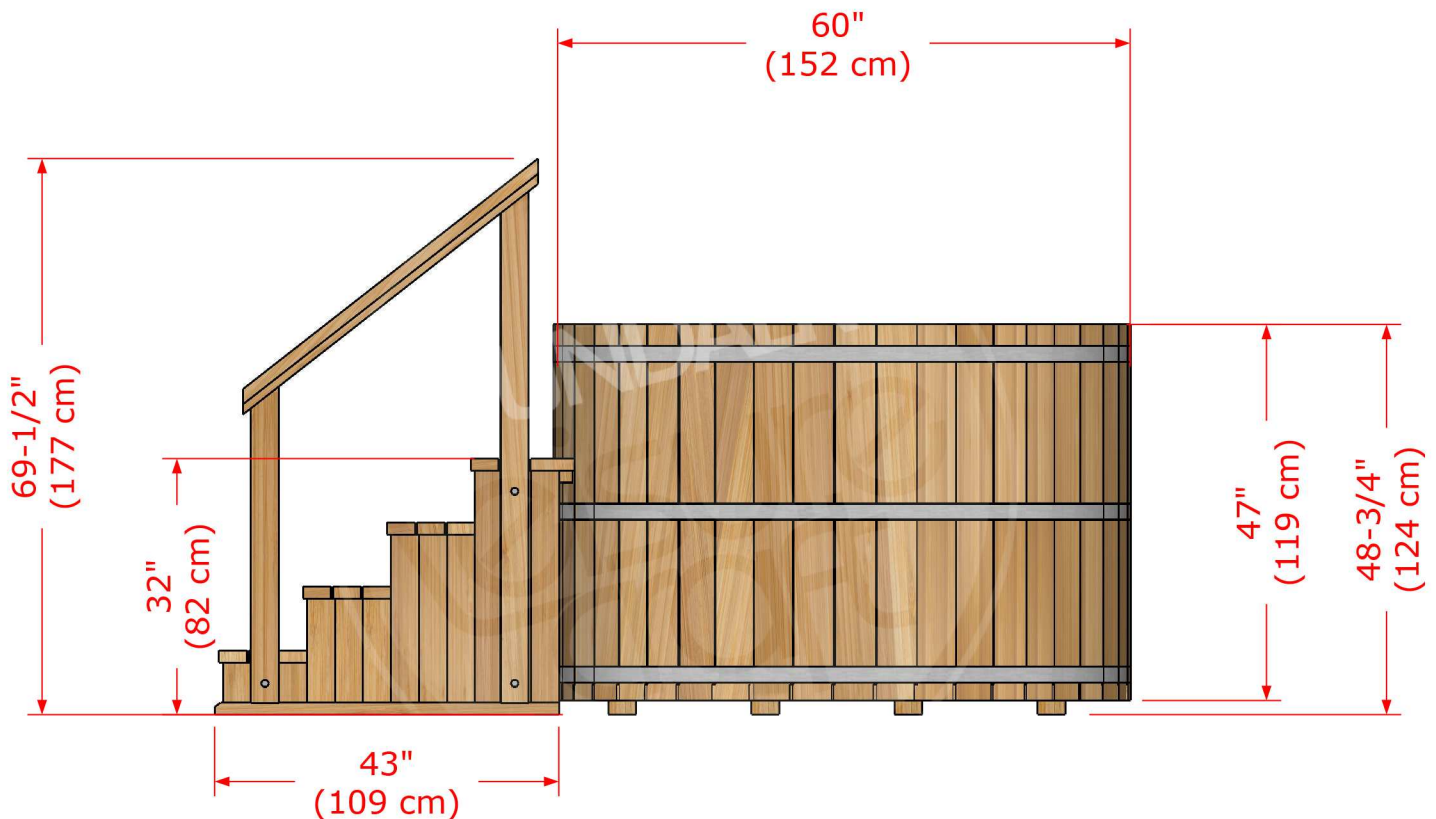

Model # 450

4' x 5' Cedar Hot Tub



Inside Tub Dimensions

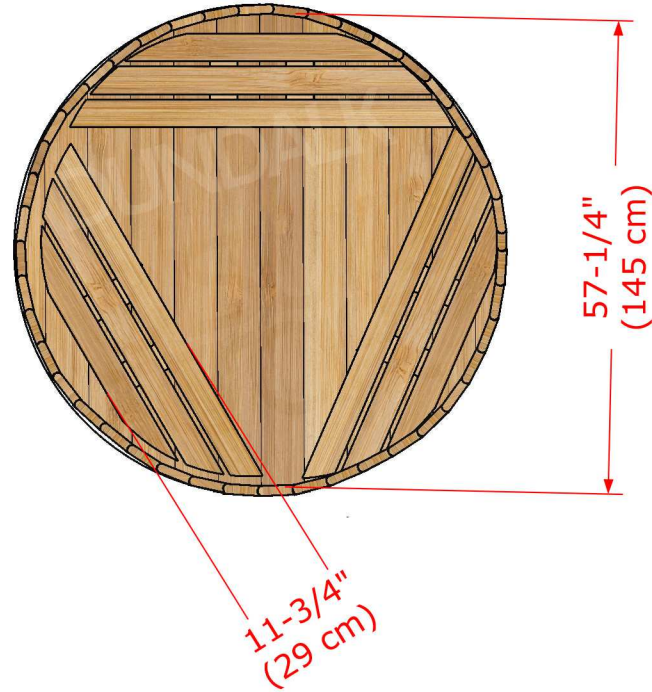

Base Dimensions

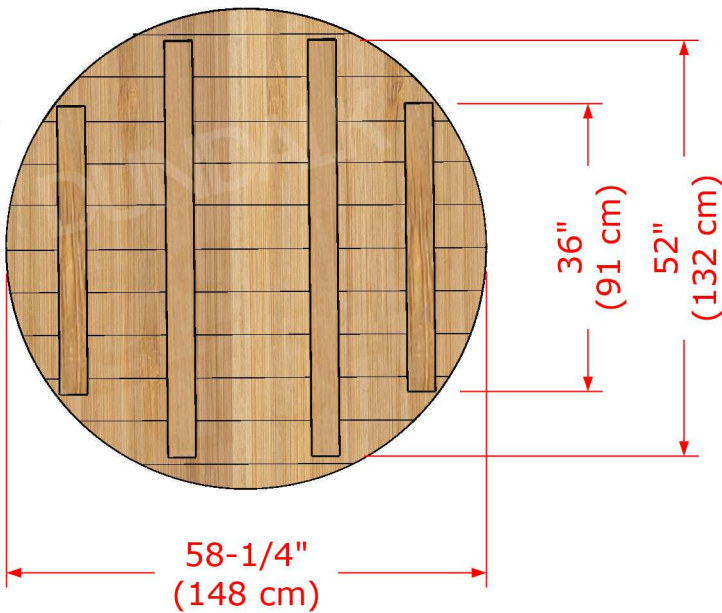

Package Size
72" x 45" x 32"
(183 cm x 114cm x 81 cm)

Product Weight
625 lbs
(283 kgs)

Cedar Hot Tub Features & Options



SB-110 Aluminum Hot Tub Heater

- Aluminum wood burning hot tub heater with 6'6 (2m) of chimney and heat protection shield on bottom.
- Using no electricity, this uniquely designed wood-burning hot tub heater takes 2 to 4 hours to heat up your tub of water (depending tub size) from 45°F to 105°F.
- Large 10 1/2" high x 22 1/2" deep x 16" wide firebox. (27cm high x 57cm deep x 41cm wide)
- 4" high x 22 1/2" deep x 8 1/2" wide Ash Box for easy clean up. (10 cm high x 57cm deep x 22cm wide)
- * Failure to ensure that stove is completely filled with water before lighting the stove will result in damage to the stove beyond repair.**

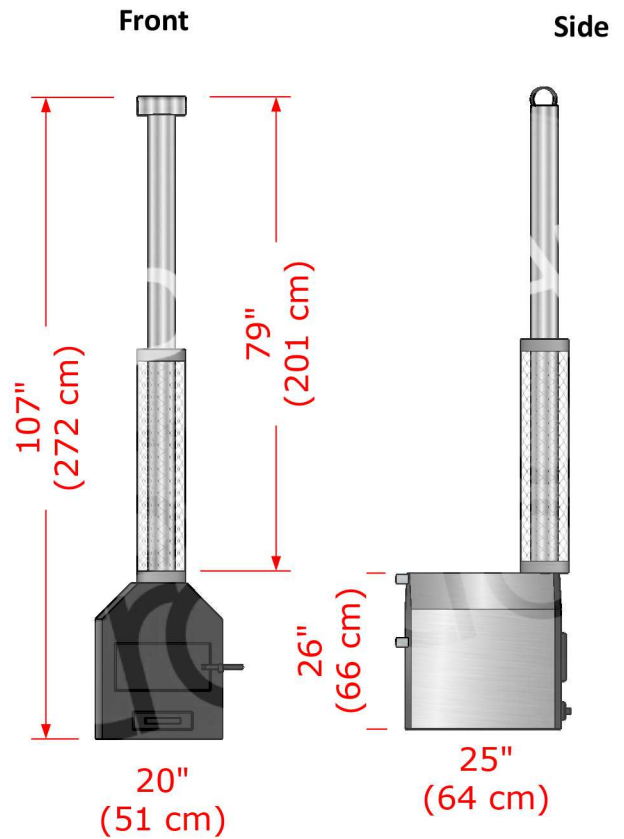

Hot tub Cover

- Insulated vinyl hot tub cover to keep the debris out of your cedar hot tub and the water warm over night.
- Available in our standard teak colour or you may choose one of our many premium colours

